

Portable 3-Burner Gas Griddle

ASSEMBLY GUIDE

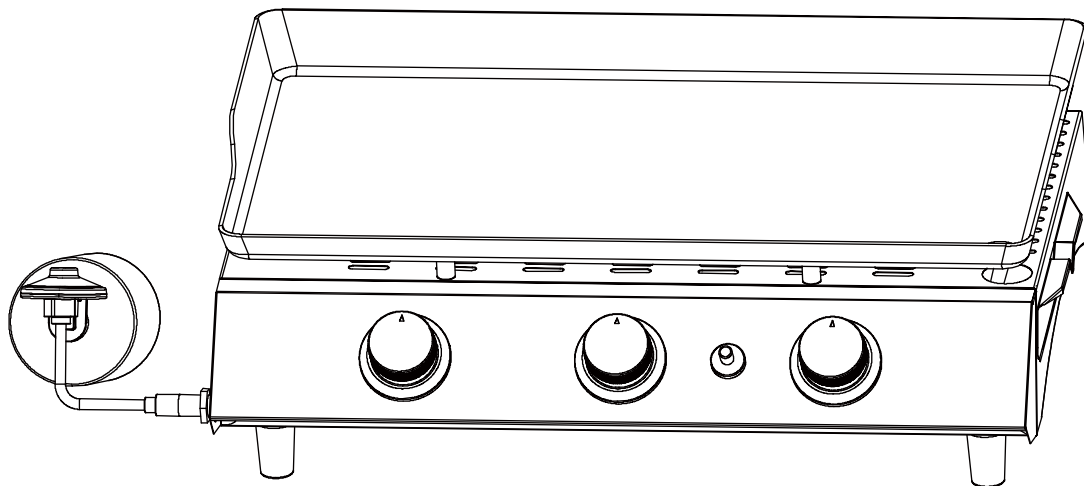

Customer Service

☎ 1-800-618-6798

FOR YOUR SAFETY!

Use outdoors only! Do not use it inside a building, garage, or any other enclosed space. Read the instructions before assembling and using the appliance. DO NOT use the griddle unless it is completely assembled, and all the parts are securely fastened. This griddle will become very hot, do not move it during use. Keep away from children and pets.

CONTACT US FIRST!

This griddle has been made to high quality standards. If you have any questions that are not addressed in this Owner's Manual, or you need parts, please call our customer service hotline or send an email to service@royalgourmetusa.com. Please keep this Owner's Manual for future reference.

Learn more at:

www.royalgourmetcorp.com

Before beginning assembly, make sure all parts are present. Compare parts with packaged contents list and diagram above. If any parts are missing or damaged, do not attempt to assemble the products. Contact customer service for replacement parts via telephone or email.



Phillips screwdriver



Wrench

- Estimated assembly time: 10 minutes
- Tools required for assembly:
Phillips screwdriver (not included) and Wrench (not included)
- Note: The right and left sides of the griddle are designed as if you are facing the front of the griddle.







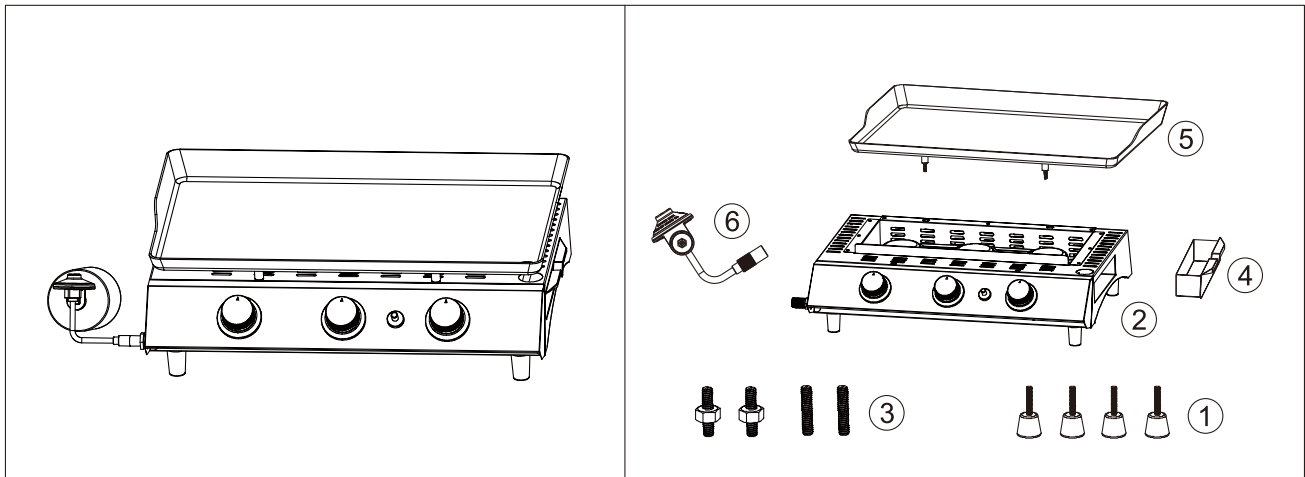

CALIFORNIA PROPOSITION 65 WARNING

1. Fuels used in gas burning appliances and the combustion byproducts of such fuels, can expose you to chemicals including carbon monoxide, which is known to the State of California to cause birth defects or other reproductive harm.
2. This product contains Nickel (Metallic) known to the State of California to cause cancer.
3. This product contains Lead and Lead Compounds known to the State of California to cause cancer and birth defects or other reproductive harm.

For more information, go to: www.P65Warnings.ca.gov



Ref	Description	Illustration	QTY
1.	Leg base assembly W-10030015		4
2.	Main body		1
3.	Stud with nut		2

Ref	Description	Illustration	QTY
4.	Grease cup W-10030011		1
5.	Cooking griddle GHJP23B-B		1
6.	Regulator W-11020007		1

Step 1

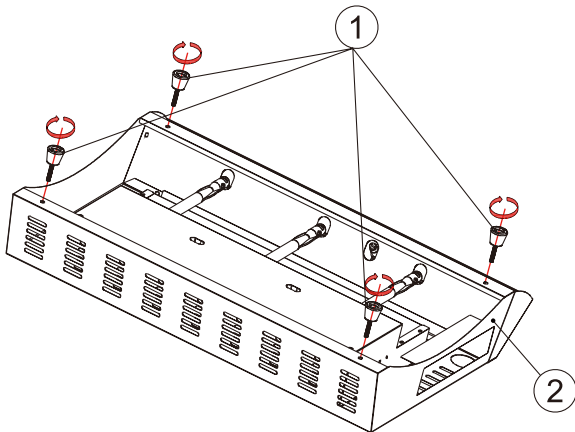

Assemble 4 leg base assemblies (1) to the bottom of the main body (2) by twisting clockwise until tightened.

Step 2

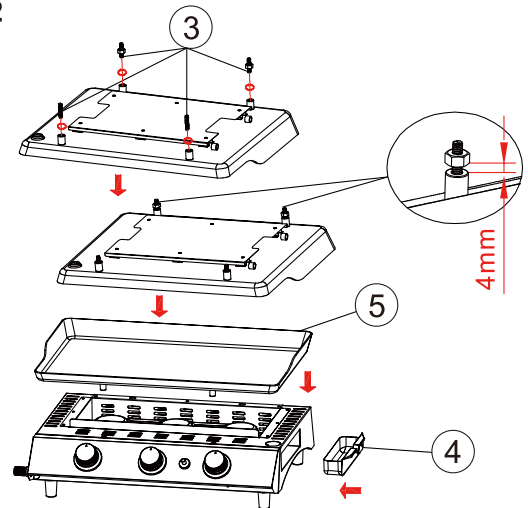

Insert the grease cup (4) to the side of the main body. Screw 4 studs (3) underneath the cooking griddle (5). Adjust the nuts to ensure the flatness of the griddle. It is recommended to leave a few inches of space from each nut to the griddle, as shown in the figure.

Step 3

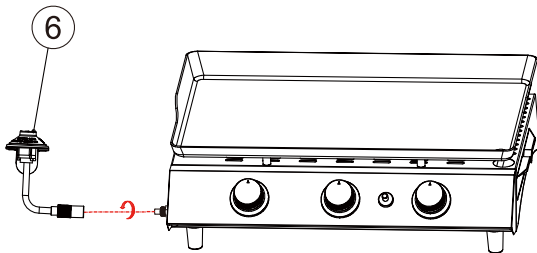

Connect the regulator (6) to the main body.

Step 4

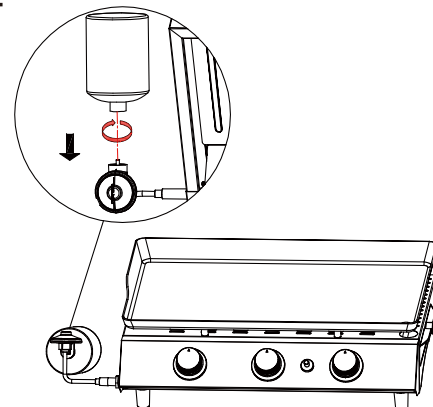

Insert the nipple of the regulator into the 1 lb. LP tank (not included) and hand tighten it by twisting clockwise as shown.

Step 5

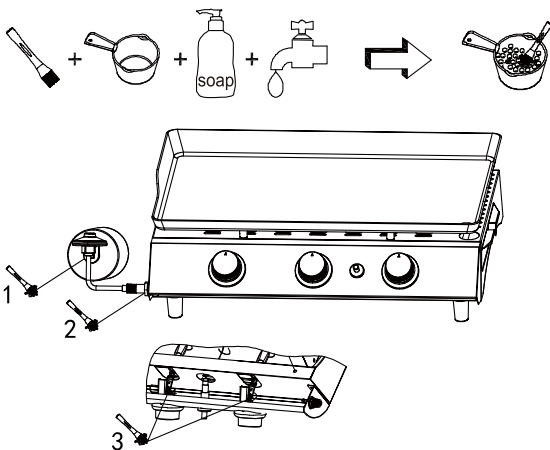

Before use, conduct the LP tank leak test as shown.

Step 6

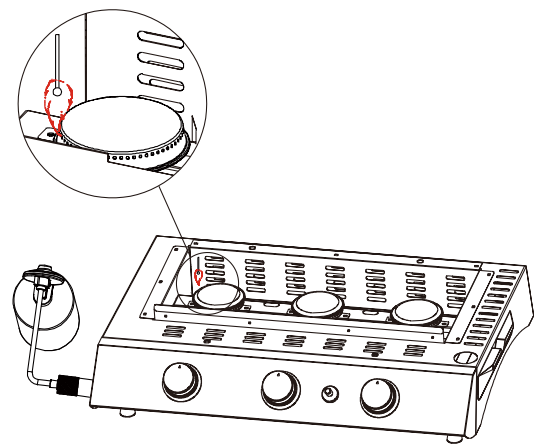

Consider to manually light the burner with a lit match stick as shown if failing to light the burner with piezo ignition.